

Spherical roller bearings, cylindrical and tapered bore

Principal dimensions			Basic load ratings		Speed ratings		Designation
d	D	B	dynamic C	static C0	Reference speed	Limiting speed	
mm			kN		r/min		
300	460	160	2821	4750	850	1200	* SKF Explorer bearing 24060 CCK30/W33 *

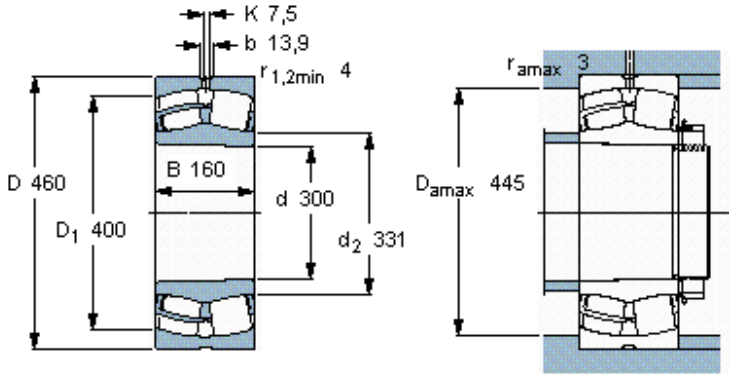

Tapered bore, taper
1: 30

Calculation factors

- e 0,33
- Y_1 2
- Y_2 3
- Y_0 2